

# ZETTLER DISPLAYS

*XIAMEN ZETTLER ELECTRONICS CO., LTD.*

## SPECIFICATIONS FOR LIQUID CRYSTAL DISPLAY

### CUSTOMER APPROVAL

※ PART NO.: ACM0802C-FLY-YBW (ZETTLER DISPLAYS) VER1.0

<b>APPROVAL</b>		<b>COMPANY CHOP</b>	
<b>CUSTOMER COMMENTS</b>			

### ZETTLER DISPLAYS ENGINEERING APPROVAL

<b>DESIGNED BY</b>	<b>CHECKED BY</b>	<b>APPROVED BY</b>
Jacky	LJF	GZH

**REVISION RECORD**

REVISION	REVISION DATE	PAGE	CONTENTS
<b>VER1.0</b>	<b>2022-03-23</b>		<b>FIRST ISSUE</b>

※ **CONTENTS**

- 1.0 GENERAL SPECS
- 2.0 ABSOLUTE MAXIMUM RATINGS
- 3.0 ELECTRICAL CHARACTERISTICS
- 4.0 OPTICAL CHARACTERISTICS
- 5.0 BLOCK DIAGRAM
- 6.0 PIN ASSIGNMENT
- 7.0 POWER SUPPLY
- 8.0 TIMING CHARACTERISTICS
- 9.0 MECHANICAL DIAGRAM
- 10.0 RELIABILITY TEST
- 11.0 DISPLAY INSTRUCTION TABLE
- 12.0 STANDARD CHARACTER PATTERNS
- 13.0 APPEARANCE CRITERIA
- 14.0 PRECAUTION FOR USING LCM
- 15.0 PACKAGING DESCRIPTION

## 1.0 GENERAL SPECS

1. Display Format	8*2 Character
2. Power Supply	5.0V
3. Module Outline Dimension	58.0mm(W) x 32.0mm(H) x max 13.5mm(D)
4. Viewing Area(W*H)	38.0mm(W) x 16.0mm(H)
5. Dot Size (W*H)	0.56mm(W) x 0.66mm(H)
6. Dot Pitch (W*H)	0.60mm(W) x 0.70mm(H)
7. Character Size (W*H)	2.96mm(W) x 5.56mm(H)
8. Character Pitch (W*H)	3.55mm(W) x 5.94mm(H)
9. Viewing Direction	6:00 O'Clock
10. Driving Method	1/16Duty,1/5Bias
11. Control IC	ST7066U-0A or Compatible
12. Display Mode	STN(Y-G)/Positive/Transflective
13. Backlight	Yellow-Green LED/SIDE
14. Operating Temperature	-20°C ~ 70°C
15. Storage Temperature	-30°C ~ 80°C
16. RoHS	RoHS compliant

## 2.0 ABSOLUTE MAXIMUM RATINGS

Item	Symbol	Min	Typ	Max	Unit
Operating temperature	Top	-20	--	70	°C
Storage temperature	Tst	-30	--	80	°C
Input voltage	Vin	Vss-0.3	--	Vdd+0.3	V
Supply voltage for logic	Vdd- Vss	2.7	--	5.5	V
Supply voltage for LCD driving	Vdd- V0	3.0	--	8.0	V

## 3.0 ELECTRICAL CHARACTERISTICS

### 3.1 Electrical Characteristics Of LCM

Item	Symbol	Condition	Min	Typ	Max	Unit
Power Supply Voltage	Vdd	25°C	4.8	5.0	5.2	V
Power Supply Current	Idd	Vdd=5.0V, fosc=270kHz	--	--	2.0	mA
Input voltage (high)	Vih	Pins:(E,RS,R/W,DB0-DB7) VDD=5V	0.7Vdd	--	Vdd	V
Input voltage (low)	Vil		-0.3	--	0.6	V
Recommended Driving Voltage LC	Vdd -V0	-20°C	4.6	4.8	5.0	V
		25°C	4.3	4.5	4.7	
		70°C	4.0	4.2	4.4	

### 3.2 The Characteristics Of LED Backlight

#### 3.2.1 Electrical-Optical Characteristics Of LED Backlight (Ta=25°C)

Item	Symbol	Condition	Min	Typ	Max	Unit
Forward Voltage <sup>(1)</sup>	Vf	If=10mA	3.9	4.1	4.3	V
Reverse Voltage	Vr	-	--	--	8	V
Luminance <sup>(2)</sup>	Lv	If=10mA	120	150	--	cd/m <sup>2</sup>
Uniformity <sup>(3)</sup>	Δ	(Lvmin/Lvmax)%	75%	--	--	-
Peak wave length	λp	If=10mA	568	570	573	nm
Lifetime <sup>(4)</sup>	-	If=10mA	-	20000	-	Hours

NOTE:

(1) Forward voltage means voltage applied directly to the LED, please refer to the backlight diagram.

(2) The luminance is the average value of 5 points, The measurement instrument is BM-7 luminance colorimeter. The diameter of aperture is Φ5mm

(3) Luminance means the backlight brightness without LCD.

(4) Backlight lifetime means luminance value larger than half of the original after 20000 hours' continuous working.

(5) Please apply the backlight current as the table recommend. If LCM surface luminance is acceptable, please apply the driving current as lower as possible. Any time, do not apply the driving current higher than 80mA.

#### 3.2.2 Backlight Control Circuit FOR LCM (1 pcs LED)

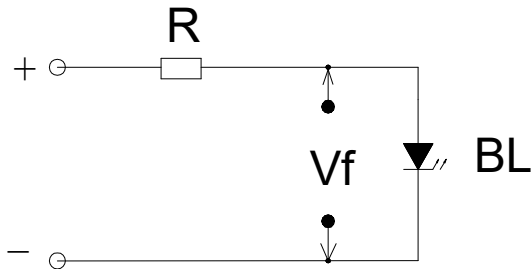

#### 3.2.3 LED Characteristics Curves (for single LED)

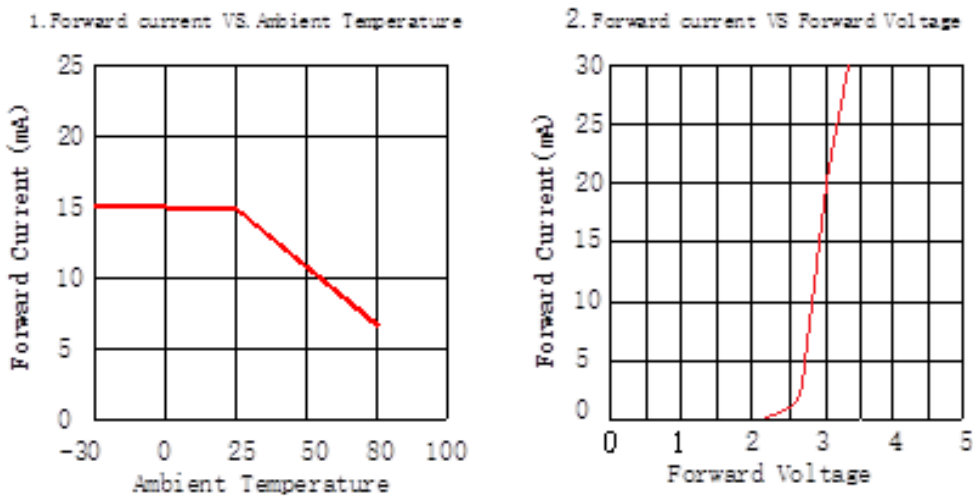

### 4.0 OPTICAL CHARACTERISTICS (Ta=25°C)

Item	Symbol	Condition	Min	Typ	Max	Unit
Viewing angle (Left - right)	$\theta_2$	$Cr \geq 2.0$	-35	-	35	deg
Viewing angle (Up-down)	$\theta_1$	$Cr \geq 2.0$	-25	-	40	deg
Contrast Ratio	Cr	$\theta_1=0^\circ, \theta_2=0^\circ$	-	3	-	
Response time (rise)	Tr	$\theta_1=0^\circ, \theta_2=0^\circ$	-	180	300	ms
Response time (fall)	Tf	$\theta_1=0^\circ, \theta_2=0^\circ$	-	150	250	ms

#### (1). Definition of Optical Response Time

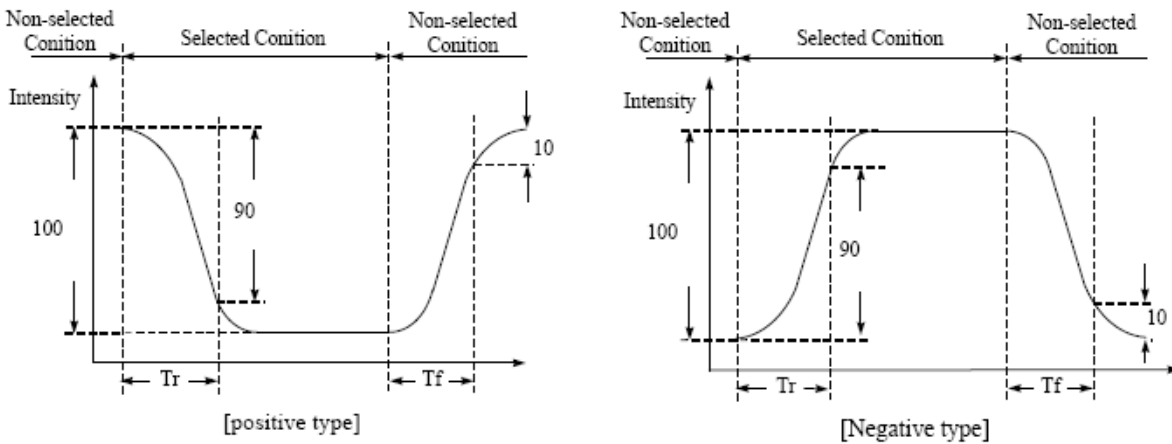

#### (2). Definition of Contrast Ratio

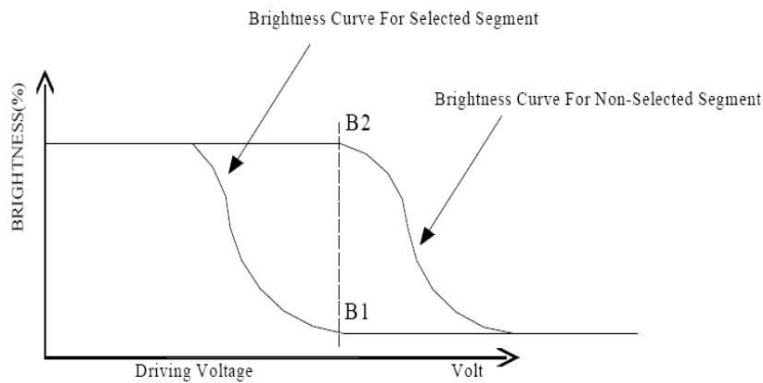

$$Cr = \frac{\text{Brightness of Non-selected Segment}(B2)}{\text{Brightness of selected Segment}(B1)}$$

#### (3). Definition of Viewing Angle $\theta_2$ and $\theta_1$

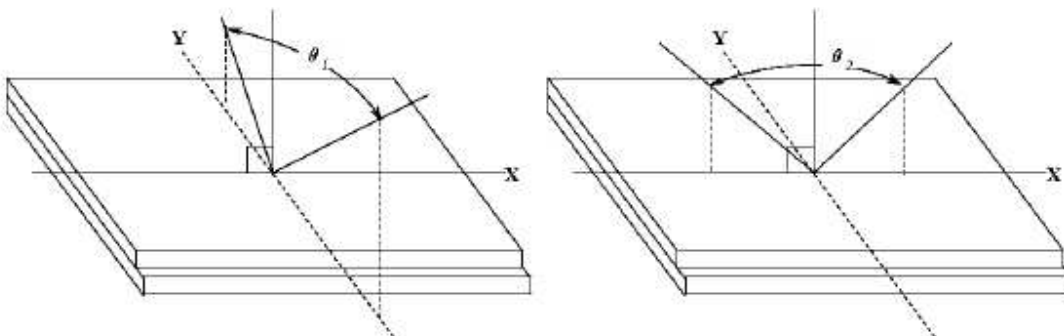

## 5.0 BLOCK DIAGRAM

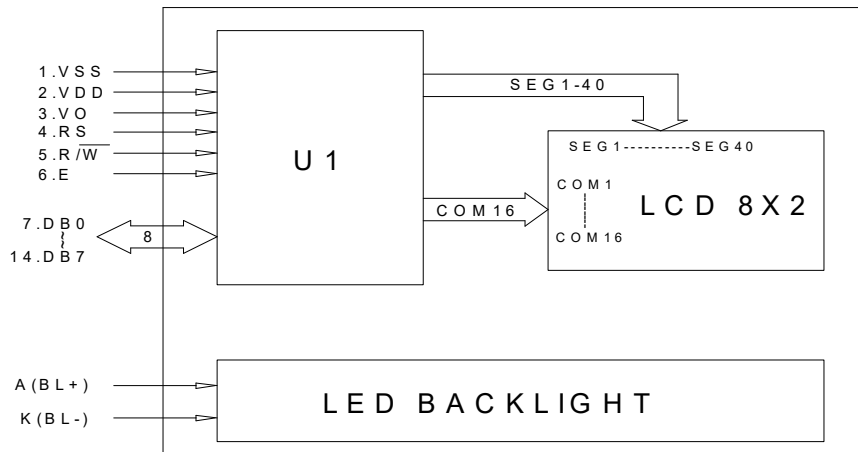

## 6.0 PIN ASSIGNMENT

Pin No.	Symbol	Function
1	Vss	Ground
2	Vdd	+5.0V
3	V0	LCD contrast adjust
4	RS	Register select
5	R/W	Read / Write Signal
6	E	Enable Signal
7	DB0	Data bit 0
8	DB1	Data bit 1
9	DB2	Data bit 2
10	DB3	Data bit 3
11	DB4	Data bit 4
12	DB5	Data bit 5
13	DB6	Data bit 6
14	DB7	Data bit 7
A	BL+	Power Supply for BL+(4.1V)
K	BL-	Power Supply for BL-(0V)

## 7.0 POWER SUPPLY

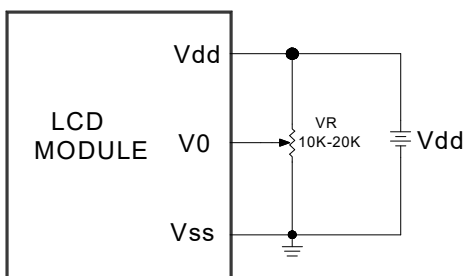

## 8.0 TIMING CHARACTERISTICS

### Write mode (Writing Data from MPU to ST7066U)

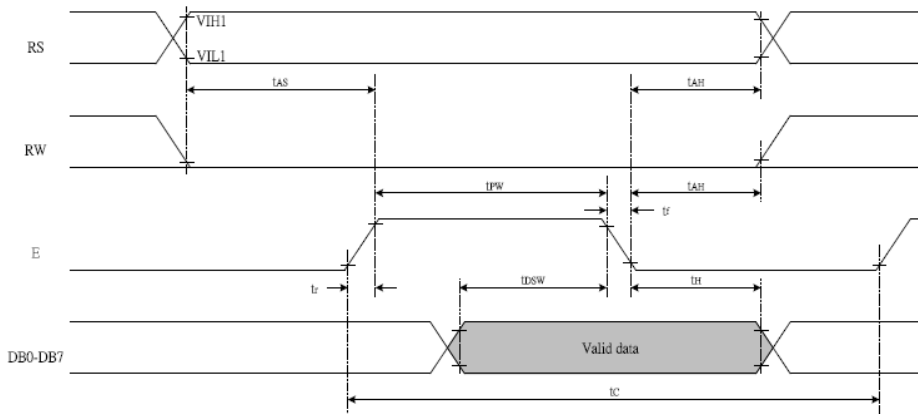

### Read mode (Reading Data from ST7066U to MPU)

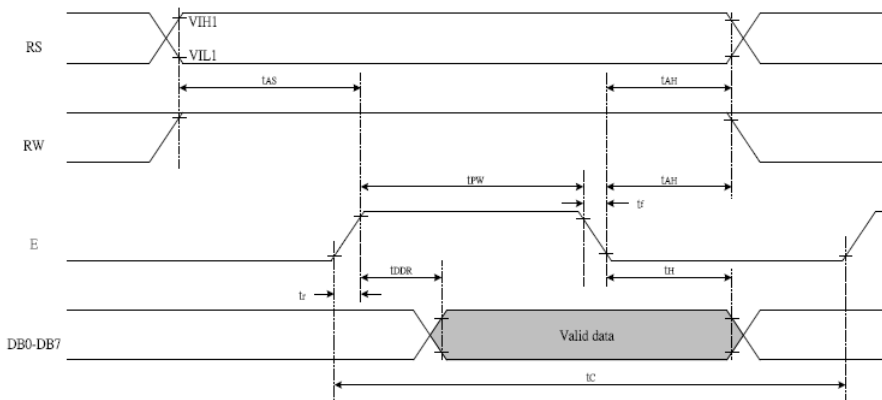

Write Mode (Writing data from MPU to ST7066U)						
$T_C$	Enable Cycle Time	Pin E	1200	-	-	ns
$T_{PW}$	Enable Pulse Width	Pin E	140	-	-	ns
$T_{R}, T_F$	Enable Rise/Fall Time	Pin E	-	-	25	ns
$T_{AS}$	Address Setup Time	Pins: RS,RW,E	0	-	-	ns
$T_{AH}$	Address Hold Time	Pins: RS,RW,E	10	-	-	ns
$T_{DSW}$	Data Setup Time	Pins: DB0 - DB7	40	-	-	ns
$T_H$	Data Hold Time	Pins: DB0 - DB7	10	-	-	ns
Read Mode (Reading Data from ST7066U to MPU)						
$T_C$	Enable Cycle Time	Pin E	1200	-	-	ns
$T_{PW}$	Enable Pulse Width	Pin E	140	-	-	ns
$T_{R}, T_F$	Enable Rise/Fall Time	Pin E	-	-	25	ns
$T_{AS}$	Address Setup Time	Pins: RS,RW,E	0	-	-	ns
$T_{AH}$	Address Hold Time	Pins: RS,RW,E	10	-	-	ns
$T_{DDR}$	Data Setup Time	Pins: DB0 - DB7	-	-	100	ns
$T_H$	Data Hold Time	Pins: DB0 - DB7	10	-	-	ns

For more details, please refer to IC specification.



9.0 MECHANICAL DIAGRAM

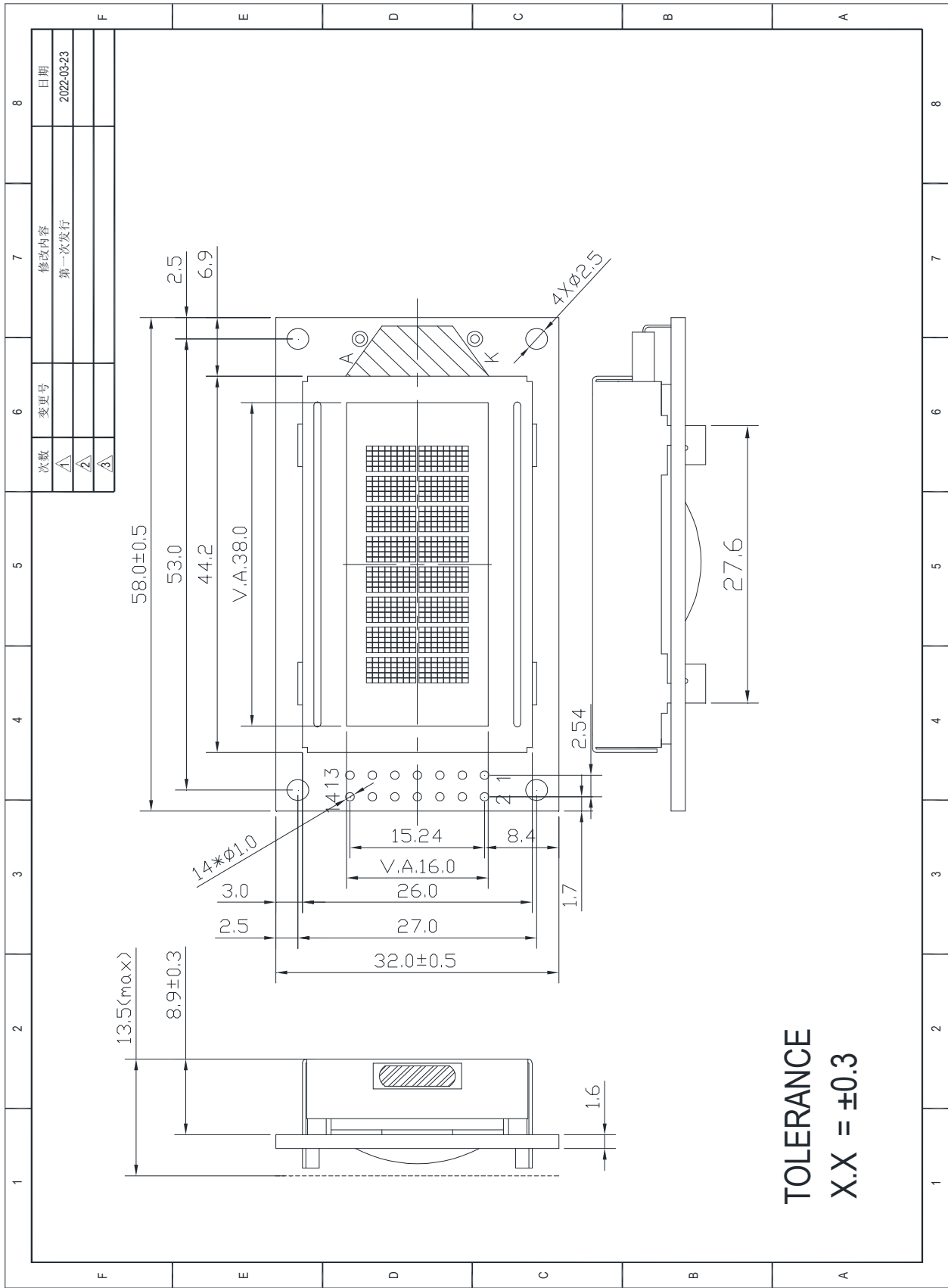

TOLERANCE  
X.X = ±0.3

**10.0 RELIABILITY TEST**

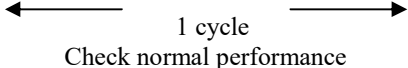
NO	Test Item	Description	Test Condition	Remark	
1	Environmental Test	High temperature storage	Applying the high storage temperature Under normal humidity for a long time Check normal performance	80 °C 96hrs	
2		Low temperature storage	Applying the low storage temperature Under normal humidity for a long time Check normal performance	-30°C 96hrs	
3		High temperature Operation	Apply the electric stress(Voltage and current) Under high temperature for a long time	70 °C 96hrs	Note1
4		Low temperature Operation	Apply the electric stress Under low temperature for a long time	-20°C 96hrs	Note1 Note2
5		High temperature/High Humidity Storage	Apply high temperature and high humidity storage for a long time	90% RH 40°C 96hrs	Note2
6		Temperature Cycle	Apply the low and high temperature cycle -30°C <> 25°C <> 80°C <> 25°C 30min 10min 30min 10min  Check normal performance	-30°C/80°C 10 cycle	
7	Mechanical Test	Vibration test(Package state)	Applying vibration to product check normal performance	Freq:10~55~10Hz Amplitude:0.75mm 1cycle time:1min X.Y.Z every direction for 15 cycles	
8		Shock test(package state)	Applying shock to product check normal performance	Drop them through 70cm height to strike horizontal plane	
9	Other				

**Remark**

Note1:Normal operations condition (25°C±5°C).

Note2:Pay attention to keep dewdrops from the module during this test.

## 11.0 DISPLAY INSTRUCTION TABLE

Instruction	Instruction Code										Description	Execution time (Temp = 25°C)			
	RS	RW	DB7	DB6	DB5	DB4	DB3	DB2	DB1	DB0		Fosc= 190KHz	Fosc= 270KHz	Fosc= 350KHz	
Clear Display	0	0	0	0	0	0	0	0	0	1	Write "20H" to DDRAM and set DDRAM address to "00H" from AC	2.16ms	1.52ms	1.18ms	
Return Home	0	0	0	0	0	0	0	0	0	1	-	Set DDRAM address to "00H" from AC and return cursor to its original position if shifted. The contents of DDRAM are not changed.	2.16ms	1.52ms	1.18ms
Entry Mode Set	0	0	0	0	0	0	0	0	1	I/D	S	Assign cursor moving direction and enable the shift of entire display	53μs	38μs	29μs
Display ON/OFF Control	0	0	0	0	0	0	0	1	D	C	B	Set display (D), cursor(C), and blinking of cursor(B) on/off control bit.	53μs	38μs	29μs
Cursor or Display Shift	0	0	0	0	0	0	1	S/C	R/L	-	-	Set cursor moving and display shift control bit, and the direction, without changing of DDRAM data.	53μs	38μs	29μs
Function Set	0	0	0	0	0	1	DL	N	F	-	-	Set interface data length (DL: 8-bit/4-bit), numbers of display line (N: 2-line/1-line) and, display font type (F:5x10 dots/5x8 dots)	53μs	38μs	29μs
Set CGRAM Address	0	0	0	1	AC5	AC4	AC3	AC2	AC1	AC0		Set CGRAM address in address counter.	53μs	38μs	29μs
Set DDRAM Address	0	0	1	AC6	AC5	AC4	AC3	AC2	AC1	AC0		Set DDRAM address in address counter	53μs	38μs	29μs
Read Busy Flag and Address Counter	0	1	BF	AC6	AC5	AC4	AC3	AC2	AC1	AC0		Whether during internal operation or not can be known by reading BF. The contents of address counter can also be read.			
Write Data to RAM	1	0	D7	D6	D5	D4	D3	D2	D1	D0		Write data into internal RAM (DDRAM/CGRAM).	53μs	38μs	29μs
Read Data from RAM	1	1	D7	D6	D5	D4	D3	D2	D1	D0		Read data from internal RAM (DDRAM/CGRAM).	53μs	38μs	29μs



12.0 STANDARD CHARACTER PATTERNS

b7-b4 b3-b0	0000	0001	0010	0011	0100	0101	0110	0111	1000	1001	1010	1011	1100	1101	1110	1111
0000	CG RAM (1)			0	1	2	3	4				—	3	4	5	6
0001	(2)	!	1	A	Q	a	q			u	7	8	G	á	g	
0010	(3)	"	2	B	R	b	r			r	/	9	X	pe	e	
0011	(4)	#	3	C	S	c	s			j	0	7	E	e	e	
0100	(5)	\$	4	D	T	d	t			\	1	1	1	1	1	
0101	(6)	%	5	E	U	e	u			*	2	2	2	2	2	
0110	(7)	&	6	F	V	f	v			3	3	3	3	3	3	
0111	(8)	'	7	G	W	g	w			4	4	4	4	4	4	
1000	(1)	<	C	H	X	h	x			5	5	5	5	5	5	
1001	(2)	>	9	I	Y	i	y			6	6	6	6	6	6	
1010	(3)	*	#	J	Z	j	z			7	7	7	7	7	7	
1011	(4)	+	;	K	L	k	l			8	8	8	8	8	8	
1100	(5)	,	<	L	#	l	l			9	9	9	9	9	9	
1101	(6)	—	=	N	I	n	i			0	0	0	0	0	0	
1110	(7)	.	>	N	^	n	*			1	1	1	1	1	1	
1111	(8)	/	?	O	_	o	+			2	2	2	2	2	2	■

## ACM0802C-FLY-YBW(ZETTLER DISPLAYS) CHARACTER MODULE VER1.0

Note: The character generator RAM is the RAM with which the user can rewrite character patterns by program.

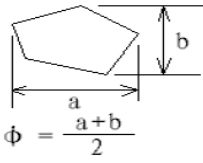
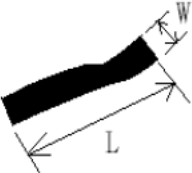
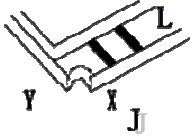
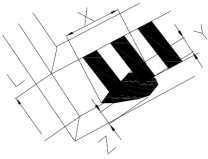
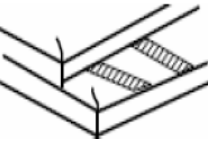
### 13.0 APPEARANCE CRITERIA

Item	Description	Picture	Specification			MA	MI	Inspection Method
Dot defects (black/white dot)	Scratches black dot white dot on the polarizer dirty spot and bubble between the polarizer and glass in the display area.	 <p><math>\phi = \frac{a+b}{2}</math></p> <p>J:the distance between dot and dot.</p>	$\leq 0.1$	Ignored		●	Visual/ contrast by Inspection standard film	
			$0.1 < \phi \leq 0.20$	2	$J > 5$			
			$0.20 < \phi \leq 0.25$	1	$J > 10$			
			$0.25 < \phi \leq 0.30$	0				
			$0\phi > 0.3$	0				
black/white line defect (straight line or curve etc. Line type defects)	Fibres in active area, scratches and black line on the glass or polarizer.	 <p>J:the distance between dot and dot.</p>	$W \leq 0.01$	Ignored		●	Visual/ contrast by Inspection standard film	
			$W \leq 0.02 \quad L \leq 5$	2	$J > 5$			
			$W \leq 0.03 \quad L \leq 4$	1	$J > 10$			
			$W \leq 0.04 \quad L \leq 3$	0	$J > 10$			
			$W \leq 0.05 \quad L \leq 2$	0				
Chip on corner	sidestep on the lower glass	 <p>Y:width of chip X:length of chip L:width of sidestep J:distance between electrode and the farthermost edge.</p>	$Y \leq 1/2L, X \leq 1$	Ignored		●	Visual/ contrast by Inspection standard film	
			$Y \leq 1/2L, X \leq 2$	2				
			$Y \leq 1/2L, X \leq 3$	1				
			$Y \leq 1/2L, X \leq 1/3J$	0	$J \leq 3$			
			$Y \leq 1/2L, X \leq 2/3J$	0	$J \leq 3$			
Crack		 <p>Y:width of crack X:length of crack L:width of sidestep T:depth of crack Z:thickness of single glass</p>	$Y \leq 1/5L \quad X \leq 5 \quad Z \leq 1/2T$	Ignored		●	Visual/ contrast by Inspection standard film	
			$Y \leq 1/4L \quad X \leq 5 \quad Z \leq 1/2T$	2				
			$Y \leq 1/3L \quad X \leq 5 \quad Z \leq 1/2T$	1				
			$Y \leq 1/3L \quad X \leq 10 \quad Z \leq 1/2T$	0				
			$Y \leq 1/3L \quad X \leq 15 \quad Z \leq 1/2T$	0				
Crack			Cracks in any area	rejected		●	Visual	
Polarizer			$\leq 0.8$	Accepted		●	Visual/	

ACM0802C-FLY-YBW(ZETTLER DISPLAYS) CHARACTER MODULE VER1.0

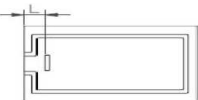
		be applicable for up/bottom polarizer	0.8<L≤1.0	Rejected			contrast by Inspection standard film
			1.0<L≤1.5	Rejected			
			1.5<L≤2.0	Rejected			
			<p>Any seeable polarizer slanting or excursion in active area will be rejected.</p> <p>The polarizer edge should be even and be line. Any indentation within 1/3 of silkscreen line will be rejected.</p> <p>Wrong direction, missing or extra, incorrect sticking for polarizer and dirty surface(grease) on polarizer will be rejected.</p> <p>seeable black silkscreen line from the arond can be accepted.</p> <p>Refer to the drawing size requirement.</p>				
End seal		 <p>L:The distance from the block to edge of glass.</p>	UV glue of seal on the glass surface	Rejected	●		Visual/contrast by Inspection standard film
			The UV glue of seal overflow into the active area.	Rejected			
			Direction of end seal is different from the drawing.	Rejected			
			Glue capacity of end seal < (1/3)*L	Rejected			
			the height and length of end seal is out of the drawing requirements.	Rejected			
Silkscreen line			silkscreen line overflow into the active area.	Rejected	●		Visual/contrast by Inspection standard film
			silkscreen line deviated in active area.	Rejected			
			bubble of silkscreen line ≥ 1/3 width of silkscreen line	Rejected			

**ACM0802C-FLY-YBW(ZETTLER DISPLAYS) CHARACTER MODULE VER1.0**

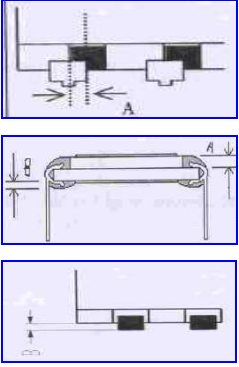
PIN			<p>Glue on PIN: there is glue on the PIN without pin clip will be rejected. PIN glue solidification: PIN glue doesn't solidify completely. The sunken or glue stain by touching will be rejected.</p> <p>PIN deflection: if deflection angle <math>&gt; \pm 5^\circ</math> , rejected; contrarily, please refer to the drawing requirement. Without continuous glue on pins will be rejected. PIN glue stains on polarizer or inleakage polarizer and glass, rejected.</p> <p>PIN glue exceeds the up polarizer, rejected.</p> <p>Missing or extra, broken pin, rejected.</p> <p>PIN loosen: no permission for pin loose or drop. Clip</p> <p>PIN:pin center exceeds 1/3 ITO width, rejected. No pin glue, rejected. UV glue range: UV glue must be exceeded over 1~1.5 pin distance from both side. if not, rejected. PIN length and direction must be same with the drawing requirements.</p>			Visual/contrast by Inspection standard film	
Protective film			<p>LCD protective film can not stick on the polarizer and the product protective film raised <math>\leq 1/3</math> length or width of polarizer from same direction of axis and its total length should be <math>\leq 15\text{mm}</math> . This defect can be accepted.</p>			Visual	
Rainbow			rainbow is not in active area.	Accepted			Visual/contrast by golden sample
			Rainbow in active area.	Rejected			
			with obvious discoloration and uneven color.	Rejected			
background color			There are obvious different background color from the same product lot.	Rejected			Visual/contrast by golden sample

**NOTE:**

Inspection condition:

Viewing distance for cosmetic inspection is 30cm with bare eyes, and under an environment of 800 lux(20W\*2---40W) light intensity, all directions for inspecting the sample should be within 45° against perpendicular line.

## 14.0 PRECAUTION FOR USING LCM

1. When design the product with this LCD Module, make sure the viewing angle matches to its purpose of usage.
2. As LCD panel is made of glass substrate, Dropping the LCD module or banging it against hard objects may cause cracking or fragmentation. Especially at corners and edges.
3. Although the polarizer of this LCD Module has the anti-glare coating, always be careful not to scratch its surface. Use of a plastic cover is recommended to protect the surface of polarizer.
4. If the LCD module is stored at below specified temperature, the LC material may freeze and be deteriorated. If it is stored at above specified temperature, the molecular orientation of the LC material may change to Liquid state and it may not revert to its original state. Excessive temperature and humidity could cause polarizer peel off or bubble. Therefore, the LCD module should always be stored within specified temperature range.
5. Saliva or water droplets must be wiped off immediately as those may leave stains or cause color changes if remained for a long time. Water vapor will cause corrosion of ITO electrodes.
6. If the surface of LCD panel needs to be cleaned, wipe it swiftly with cotton or other soft cloth. If it is not still clean enough, blow a breath on the surface and wipe again.
7. The module should be driven according to the specified ratings to avoid malfunction and permanent damage. Applying DC voltage cause a rapid deterioration of LC material. Make sure to apply alternating waveform by continuous application of the M signal. Especially the power ON/OFF sequence should be kept to avoid latch-up of driver LSIs and DC charge up to LCD panel.
8. Mechanical Considerations
  - a) LCM are assembled and adjusted with a high degree of precision. Avoid excessive shocks and do not make any alterations or modifications. The following should be noted.
  - b) Do not tamper in any way with the tabs on the metal frame.
  - c) Do not modify the PCB by drilling extra holes, changing its outline, moving its components or modifying its pattern.
  - d) Do not touch the elastomer connector; especially insert a backlight panel (for example, EL).
  - e) When mounting a LCM makes sure that the PCB is not under any stress such as bending or twisting. Elastomer contacts are very delicate and missing pixels could result from slight dislocation of any of the elements.
  - f) Avoid pressing on the metal bezel, otherwise the elastomer connector could be deformed and lose contact, resulting in missing pixels.
9. Static Electricity
  - a) Operator

**Wear the electrostatics shielded clothes because human body may be statically charged if not wear shielded clothes. Never touch any of the conductive parts such as the LSI pads; the copper leads on the PCB and the interface terminals with any parts of the human body.**

b) Equipment

There is a possibility that the static electricity is charged to the equipment, which has a function of peeling or friction action (ex: conveyer, soldering iron, working table). Earth the equipment through proper resistance (electrostatic earth:  $1 \times 10^8$  ohm).

Only properly grounded soldering irons should be used.

If an electric screwdriver is used, it should be well grounded and shielded from commutator sparks.

The normal static prevention measures should be observed for work clothes and working benches; for the latter conductive (rubber) mat is recommended.

c) Floor

**Floor is the important part to drain static electricity, which is generated by operators or equipment.**

There is a possibility that charged static electricity is not properly drained in case of insulating floor. Set the electrostatic earth (electrostatic earth:  $1 \times 10^8$  ohm).

d) Humidity

Proper humidity helps in reducing the chance of generating electrostatic charges. Humidity should be kept over 50%RH.

e) Transportation/storage

**The storage materials also need to be anti-static treated because there is a possibility that the human body or storage materials such as containers may be statically charged by friction or peeling.**

The modules should be kept in antistatic bags or other containers resistant to static for storage.

f) Soldering

Solder only to the I/O terminals. Use only soldering irons with proper grounding and no leakage.

Soldering temperature :  $355^{\circ} \text{C} \pm 10^{\circ} \text{C}$



Soldering time: 3 to 4 sec.

Use eutectic solder with resin flux fill.

If flux is used, the LCD surface should be covered to avoid flux spatters. Flux residue should be removed afterwards.

g) Others

**The laminator (protective film) is attached on the surface of LCD panel to prevent it from scratches or stains. It should be peeled off slowly using static eliminator.**

Static eliminator should also be installed to the workbench to prevent LCD module from static charge.

10. Operation

- a) Driving voltage should be kept within specified range; excess voltage shortens display life.
  - b) Response time increases with decrease in temperature.
  - c) Display may turn black or dark blue at temperatures above its operational range; this is (however not pressing on the viewing area) may cause the segments to appear "fractured".
  - d) Mechanical disturbance during operation (such as pressing on the viewing area) may cause the segments to appear "fractured".
11. If any fluid leaks out of a damaged glass cell, wash off any human part that comes into contact with soap and water. The toxicity is extremely low but caution should be exercised at all the time.
  12. Disassembling the LCD module can cause permanent damage and it should be strictly avoided.
  13. LCD retains the display pattern when it is applied for long time (Image retention). To prevent image retention, do not apply the fixed pattern for a long time. Image retention is not a deterioration of LCD. It will be removed after display pattern is changed.
  14. Do not use any materials, which emit gas from epoxy resin (hardener for amine) and silicone adhesive agent (dealcohol or deoxym) to prevent discoloration of polarizer due to gas.
  15. Avoid the exposure of the module to the direct sunlight or strong ultraviolet light for a long time.

**15. PACKAGING DESCRIPTION**

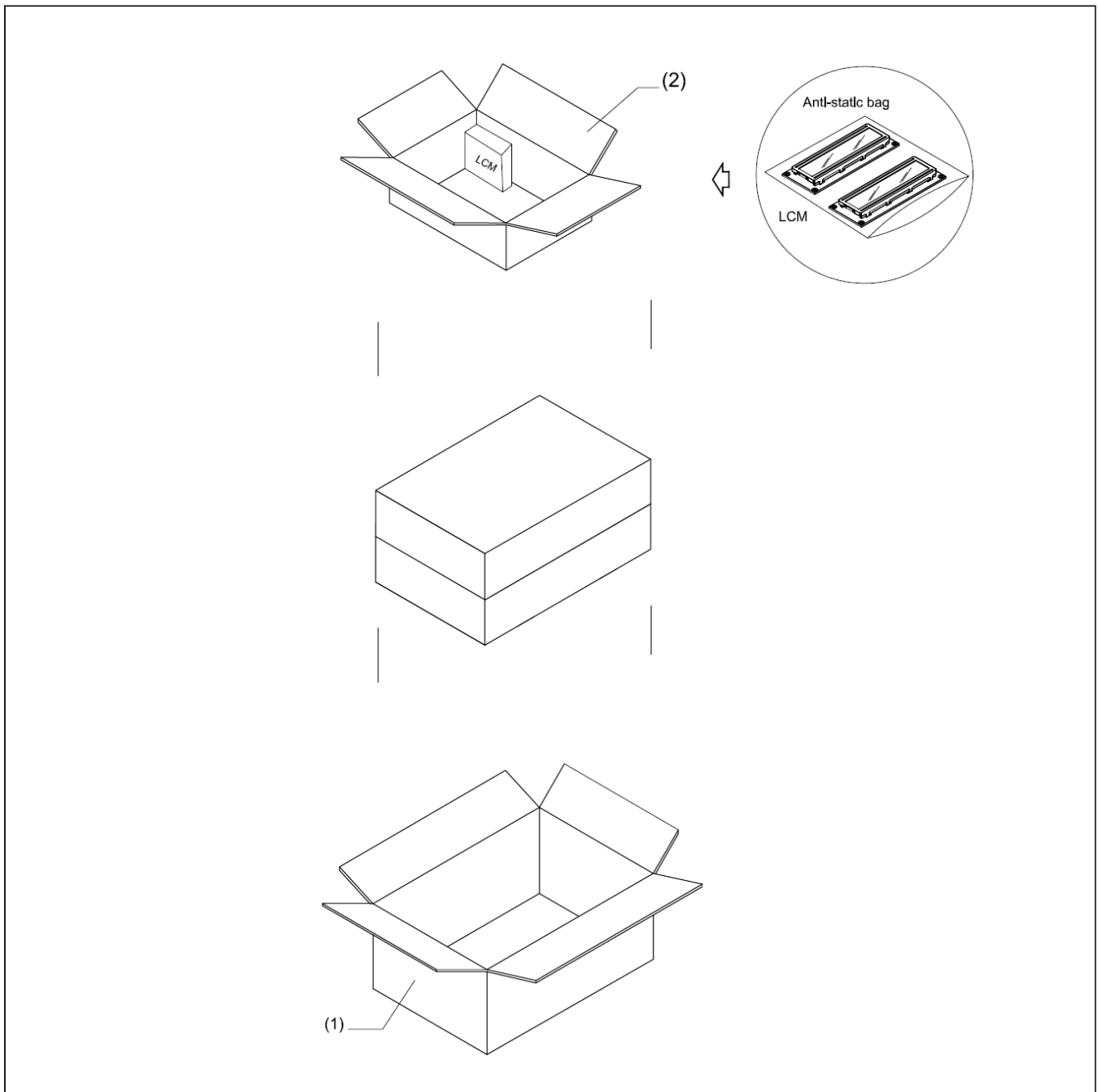

Item	Size(L*W*H)		Quantity	Note
1.Master Carton	550*315*305mm		1	
2.Inner Carton	300*270*56mm		10	
Quantity Per Inner Carton	80	Quantity Per Master Carton	800	
N.W	18.2(kg)	G.W	20.2(kg)	